

Linear

LINI Asymmetric AS30 (30W) Fixture Guide

KKDC

Indoor | Surface | Output up to 3630lm/m (853lm/ft)

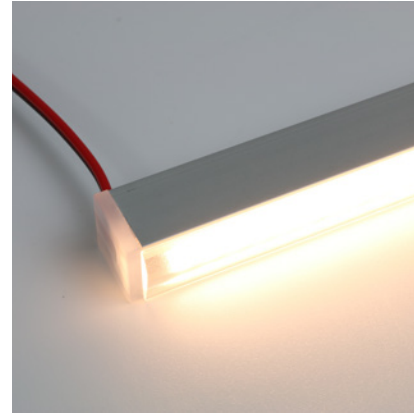
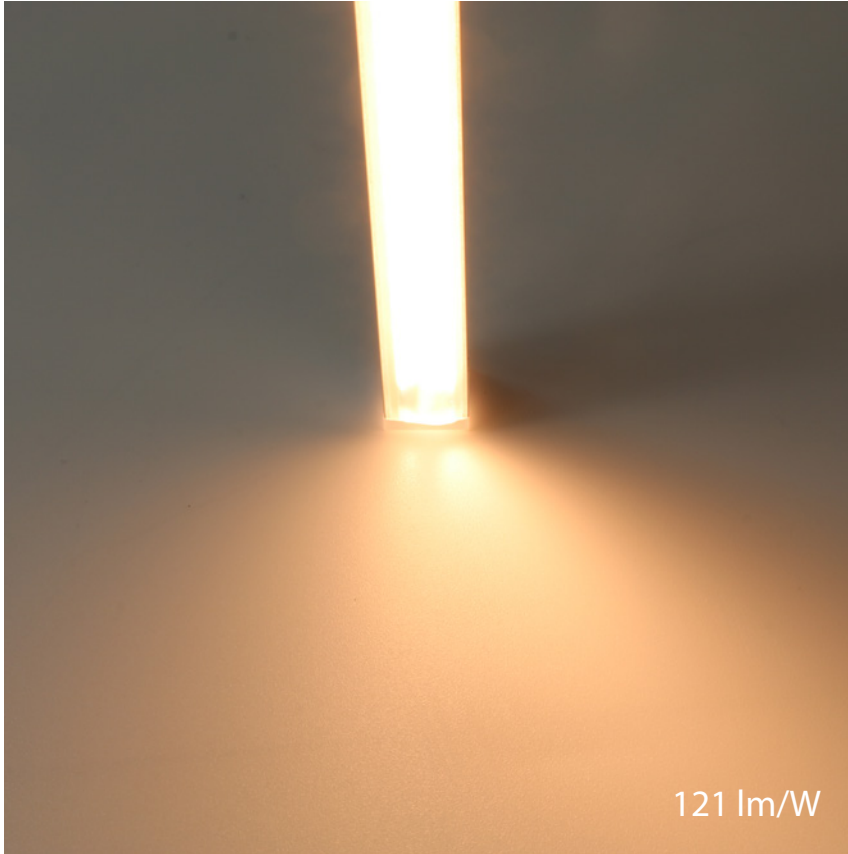

Key applications

- ✓ Architectural detail
- ✓ Backlighting & signage
- ✓ Ceiling
- ✓ Direct lighting
- ✓ Interior
- ✓ Picture display
- ✓ Retail display
- ✓ Wallwashing

Key features

- ✓ A-line (High Efficacy)
- ✓ Asymmetric lens
- ✓ Custom lengths
- ✓ Constant Voltage (CV)
- ✓ High lumen efficacy
- ✓ IP40 dry area

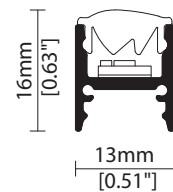

MOUNTING METHODS



KKCP-10 Concealed clip

Linear

LINI Asymmetric AS30 (30W)

Specification sheet



Dimensions	H16/W13/L93-1016mm* (H0.63/W0.51/L3.66-40in*) *KKLN-A2 = 1010mm/39.76in Max
PCB Cut-point	38.46mm increment/1000mm max (1.51in increment/39.37in max)
LED Pitch	4.8mm - 208LED/m (0.19in - 64LED/ft)
Chip	A-line
Cover/Optics	KKLN-A2 Asymmetric lens (Beam tilt 25°, Beam angle 45°)
CCT	A-line: 2700K/3000K/4000K
LED binning	A-line: 3-step MacAdam ellipse
CRI	94
Lifetime	50,000 hours @ 25°C (50,000 hours @ 77°F)
Operating temp	T _a = -25 to 45°C (T _c max = 75.1°C) T _a = -13 to 113°F (T _c max = 167°F)
IP Rating	IP40
Finish	Silver anodised
Mounting	Surface mounting via concealed clips
Power feed	Hardwire tails or male/female connectors
Control	0-10V/1-10V/DMX/DALI



LED Grading Key

Exclusive Grade *KKDC tuned CCT range
A-line* 3-step CCT range
 KKDC highest lumen efficacy LED

Power consumption	Supply voltage	Supply current
30W/m (9.14W/ft)	24V DC	1.25A/m (0.381A/ft)

Performance Data (3000K)

	R1	R2	R3	R4	R5	R6	R7	R8	R9	R10	R11	R12	R13	R14		
A-line	95	96	96	94	93	94	94	87	70	90	94	77	95	97		
	KKLN-A2															
													CRI	R9	Rf	Rg
A-line	3630lm/m (853lm/ft) 121lm/W												94	70	-	-

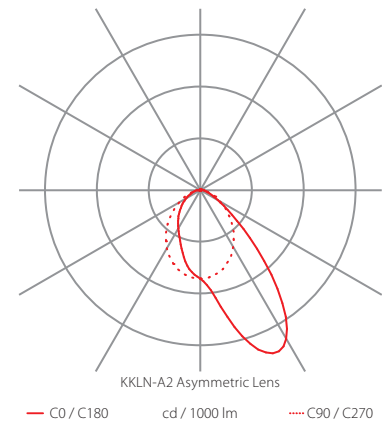
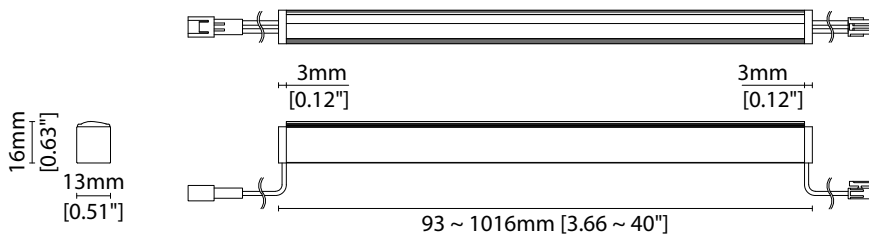

Data derived from independent UKAS/IESNA LM-79-08 accredited testing of production samples.

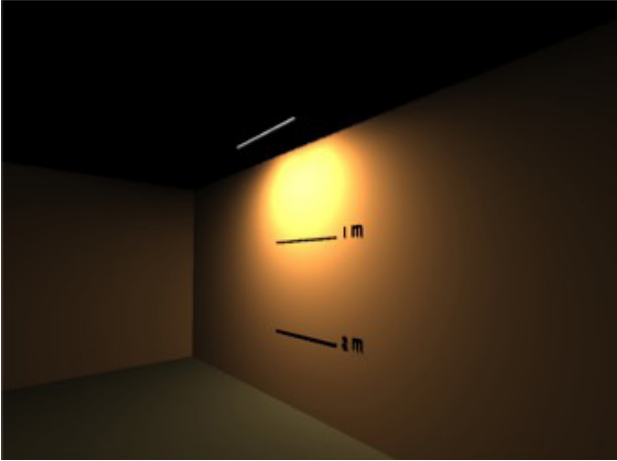

0.5M between light and wall

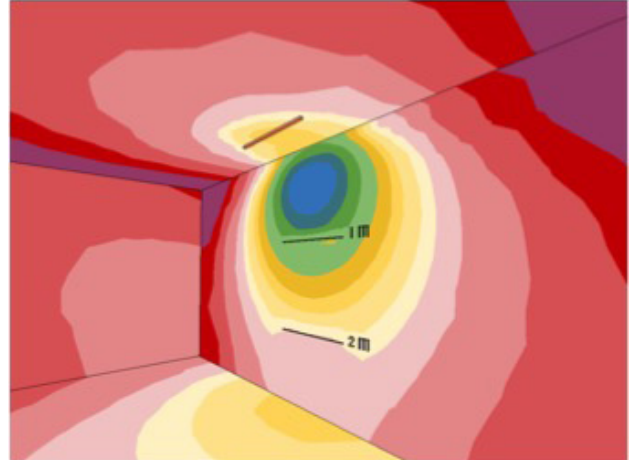

0.5M between light and wall (Psuedo color)

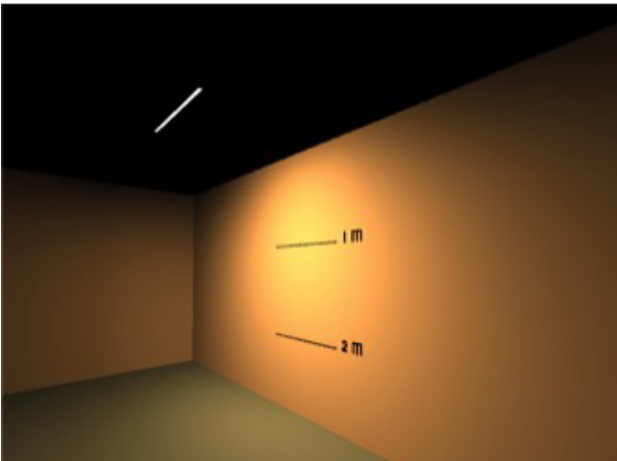

1M between light and wall

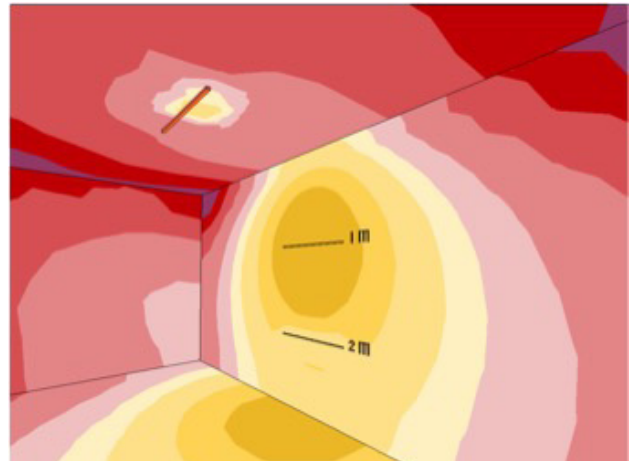

1M between light and wall (Psuedo color)

Distance between wall and light	Light reaching height (based on wall)
0.5M	1M
1.1M	1.5M
1.3M	2M

Linear

LINI Asymmetric AS30 (30W) Code Table



FIXTURE

Model	Finish	Cover/Lens ¹	Grade ²	LED	Colour (CCT)	Length Availability ³	IP	Cable Length	Power Feed ⁴	Input
LINI Asymmetric	LY Silver Anodised SA	KKLN-A2 Asymmetric A2	A-	A	AS30	2700K 27 3000K 30 4000K 40	m 93-1016mm 38.46mm increments i 3.66-40in 1.51in increments (Specify length code OR total run length)	IP40 40 300mm (11.81in) 0300	Single no sheath tail S00X Double no sheath tail D00X Single no sheath IP20 connector S20X Double no sheath IP20 connector D20X	DC 24V g

¹ Refer to **Cover/Lens Options** on **Options** pages ² Refer to **LED Grading Key** on **Specification sheet** page ³ Refer to **Length Availability List** or enter total run length instead of length code

⁴ Refer to **Power Feed Options** on **Options** pages

Code Example:

LY	-	SA	-	A2	-	A	-	AS30	-	30	-	m	516	-	40	-	0300	-	D20X	-	g
LINI Asymmetric		Silver Anodised		KKLN-A2 Asymmetric		A-		AS30		3000K		516mm		IP40		300mm (11.81in)		Double no sheath IP20 connector		DC 24V	

ACCESSORIES

Mounting Accessories

KKCP-11 Concealed clip

* Refer to **Mounting Accessories** on **Accessories** pages

Connection Accessories

KKCN-01 2 PIN male & female 50mm (1.97in) pair

KKCN-03 2 PIN male & female 300mm (11.81in) pair

KKCN-06 2 PIN 300mm (11.81in) extension lead

* Refer to **Power feed** on **Accessories** pages

PSU/Driver

0-10V/1-10V/DALI/DMX

* Refer to **Driver/PSU Options** page for details or provide requirement and KKDC to offer the suitable option

LINI Asymmetric AS30 (30W)

Length Availability List



Length Code		Fixture Length ¹		LED Strip ²		End Cap Dimension		Wattage (W)	Output (lm)
Metric	Imperial(US)	Metric	Imperial(US)	Metric	Imperial(US)	Metric	Imperial(US)		
m0093	i0004	93mm	3.66in	77mm	3.03in	6mm	0.24in	2.31	279
m0131	i0005	131mm	5.17in	115mm	4.54in	6mm	0.24in	3.46	419
m0170	i0007	170mm	6.69in	154mm	6.06in	6mm	0.24in	4.62	558
m0208	i0008	208mm	8.20in	192mm	7.57in	6mm	0.24in	5.77	698
m0247	i0010	247mm	9.72in	231mm	9.09in	6mm	0.24in	6.92	838
m0285	i0011	285mm	11.23in	269mm	10.60in	6mm	0.24in	8.08	977
m0324	i0013	324mm	12.74in	308mm	12.11in	6mm	0.24in	9.23	1117
m0362	i0014	362mm	14.26in	346mm	13.63in	6mm	0.24in	10.38	1257
m0401	i0016	401mm	15.77in	385mm	15.14in	6mm	0.24in	11.54	1396
m0439	i0017	439mm	17.29in	423mm	16.66in	6mm	0.24in	12.69	1536
m0478	i0019	478mm	18.80in	462mm	18.17in	6mm	0.24in	13.85	1675
m0516	i0020	516mm	20.31in	500mm	19.69in	6mm	0.24in	15.00	1815
m0554	i0022	554mm	21.83in	538mm	21.20in	6mm	0.24in	16.15	1955
m0593	i0023	593mm	23.34in	577mm	22.71in	6mm	0.24in	17.31	2094
m0631	i0025	631mm	24.86in	615mm	24.23in	6mm	0.24in	18.46	2234
m0670	i0026	670mm	26.37in	654mm	25.74in	6mm	0.24in	19.62	2373
m0708	i0028	708mm	27.89in	692mm	27.26in	6mm	0.24in	20.77	2513
m0747	i0029	747mm	29.40in	731mm	28.77in	6mm	0.24in	21.92	2653
m0785	i0031	785mm	30.91in	769mm	30.28in	6mm	0.24in	23.08	2792
m0824	i0032	824mm	32.43in	808mm	31.80in	6mm	0.24in	24.23	2932
m0862	i0034	862mm	33.94in	846mm	33.31in	6mm	0.24in	25.38	3072
m0901	i0035	901mm	35.46in	885mm	34.83in	6mm	0.24in	26.54	3211
m0939	i0037	939mm	36.97in	923mm	36.34in	6mm	0.24in	27.69	3351
m0978	i0038	978mm	38.49in	962mm	37.86in	6mm	0.24in	28.85	3490
m1016	i0040	1016mm	40.00in	1000mm	39.37in	6mm	0.24in	30.00	3630

¹ Actual total overall length of light fixture (LED strip + end caps + void/wire hole)

² Actual length of PCB strip

³ Actual length of 2x end caps

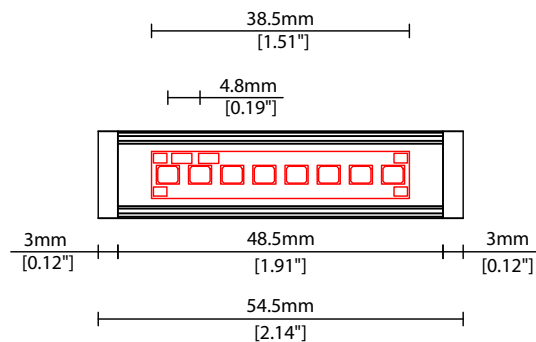

Linear

LINI Asymmetric AS30 (30W) Options

KKDC

COVER/LENS OPTIONS

* Options are an integral part of the fixture ordering codes. Please refer to **Code Table** pages.

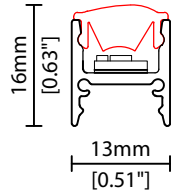

A2 KKLN-A2 Asymmetric
W13/H16mm (W0.51/H0.63")

POWER FEED OPTIONS

0300 S00X 300mm (11.81") Single no sheath tail

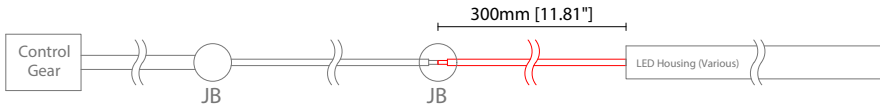

0300 D00X 300mm (11.81") Double no sheath tail

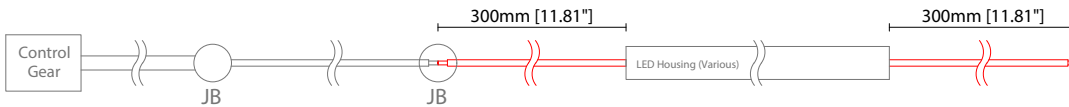

0300 S20X 300mm (11.81") Single no sheath IP20 connector

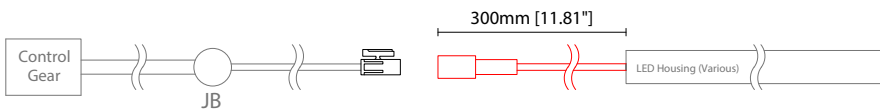

0300 D20X 300mm (11.81") Double no sheath IP20 connector

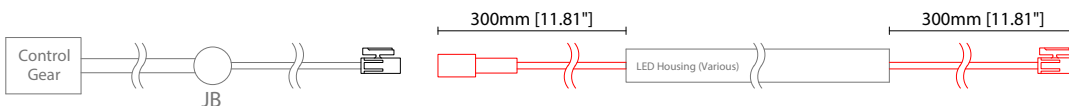

2 Pin Female Connector

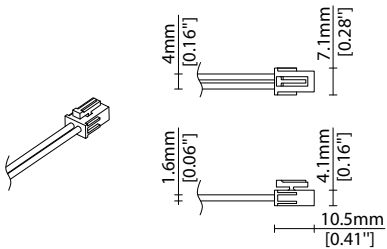

2 Pin Male Connector

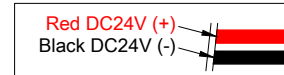
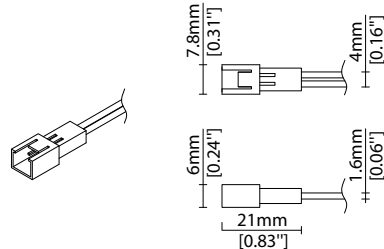

Key

Control Gear Power supply, sub-controllers & control systems
 JB Junction box / cable connection

MOUNTING ACCESSORIES

Note: Accessories are to be ordered separately with corresponding code shown below.



KKCP-10

Concealed clip
(allow 3 per metre/40in)
S/Steel finish
L20/W13/H14.2mm
(L0.79/W0.51/H0.56")

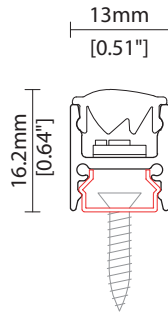

POWER FEED

Note: Accessories are to be ordered separately with corresponding code shown below.

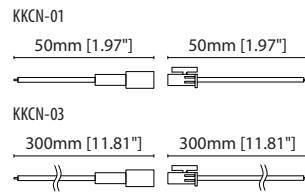

KKCN-01 50mm (1.97in) pair

KKCN-03 300mm (11.81in) pair

2 PIN male + female connector set

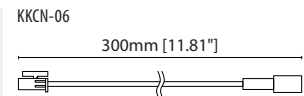

KKCN-06

2 PIN 300mm (11.81in) extension lead

Linear

LINI Asymmetric AS30 (30W) Accessories

KKDC

KKDC CONTROL



IP20
Plastic housing
L170/W59/H29mm
(L6.69/W2.32/H1.14in)

KKDM-06 1-10V

visDIM dimmable sub-controller
(4 x 8A max @ 12-36V)



IP20
Plastic housing
L170/W53.4/H28mm
(L6.69/W2.10/H1.10in)

KKSC-05 DMX

visDIM dimmable sub-controller
(4 x 5A max @ 12-36V)



IP20
Plastic housing
L170/W59/H29mm
(L6.69/W2.32/H1.14in)

KKDL-02 DALI

visDIM dimmable sub-controller
(4 x 8A max @ 12-36V)



IP20
Plastic housing
L166/W53.4/H23mm
(L6.54/W2.10/H0.91in)

KKDL-03 DALI

visDIM dimmable sub-controller
(4 x 5A max @ 12-36V)

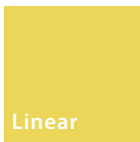

LINI

Driver/PSU Options



AVAILABLE PSU OPTIONS

Control Mode	PSU (Order Code)	Input Voltage AC	Output Voltage DC	Rated Output Current	Rated Power	Dim %	IP Rating
Switched	CEN-60-24	90-295V	24V	2.5A	60W	-	IP67
	HLG-60H-24	90-305V	24V	2.5A	60W	-	IP67
	HLG-100H-24	90-305V	24V	4.0A	100W	-	IP67
	HLG-150H-24	90-305V	24V	6.3A	150W	-	IP67
	HLG-240H-24	90-305V	24V	10A	240W	-	IP67
0-10V (1-10V)	PWM-40-24	90-305V	24V	1.67A	40W	100-0.15 (100-10)	IP67
	PWM-60-24	90-305V	24V	2.5A	60W	100-0.15 (100-10)	IP67
	PWM-90-24	90-305V	24V	3.67A	90W	100-0.15 (100-10)	IP67
	PWM-120-24	90-305V	24V	5.0A	120W	100-0.15 (100-10)	IP67
DALI	LIN100A1	120-277V	24V	1A per channel	100W	100-0.1	IP66/IP40
DMX RGB	LIN100A1	120-277V	24V	1.33A per channel	100W	100-0.1	IP66/IP40
DMX RGBW	LIN100A1	120-277A	24V	1A per channel	100W	100-0.1	IP66/IP40

Flicker Free Options - Combination of PSU+ sub-controller

Control Mode	PSU (Order Code)	Sub-controller (Order Code)	Input Voltage AC	Output Voltage DC	Rated Output Current	Rated Power	Dim %	IP Rating PSU/ Sub-controller
0-10V or 1-10V	CEN-60-24	KKDM-06	90-295V	24V	2.5A	60W	100-0.9	IP67/IP20
	HLG-60H-24	KKDM-06	90-295V	24V	2.5A	60W	100-0.9	IP67/IP20
	HLG-100H-24	KKDM-06	90-295V	24V	4.0A	100W	100-0.9	IP67/IP20
	HLG-150H-24	KKDM-06	90-295V	24V	6.3A	150W	100-0.9	IP67/IP20
	HLG-240H-24	KKDM-06	90-295V	24V	10.0A	240W	100-0.9	IP67/IP20
DALI	CEN-60-24	KKDL-02/03	90-295V	24V	2.5A	60W	100-0.1	IP67/IP20
	HLG-60H-24	KKDL-02/03	90-305V	24V	2.5A	60W	100-0.1	IP67/IP20
	HLG-100H-24	KKDL-02/03	90-305V	24V	4.0A	100W	100-0.1	IP67/IP20
	HLG-150H-24	KKDL-02/03	90-305V	24V	6.3A	150W	100-0.1	IP67/IP20
	HLG-240H-24	KKDL-02/03	90-305V	24V	10.0A	240W	100-0.1	IP67/IP20
DMX RGB	CEN-60-24	KKSC-05	90-295V	24V	2.5A	60W	100-0.9	IP67/IP20
	HLG-60H-24	KKSC-05	90-305V	24V	2.5A	60W	100-0.9	IP67/IP20
	HLG-100H-24	KKSC-05	90-305V	24V	4A	100W	100-0.9	IP67/IP20
	HLG-150H-24	KKSC-05	90-305V	24V	6.3A	150W	100-0.9	IP67/IP20
	HLG-240H-24	KKSC-05	90-305V	24V	10.0A	240W	100-0.9	IP67/IP20

¹ The items shown above cover the most frequently used specification but does not exhaust the possible options

² PSU and/or driver can be chosen from the table, or KKDC may recommend the best option upon receipt of the controls requirement and installation environment

³ Electrical shop drawing will include detailed information of PSU and relevant control drivers

⁴ Cut sheets are available on the controls section of www.kkdc.lighting or upon request